

2

Plot: 300,27 m<sup>2</sup>

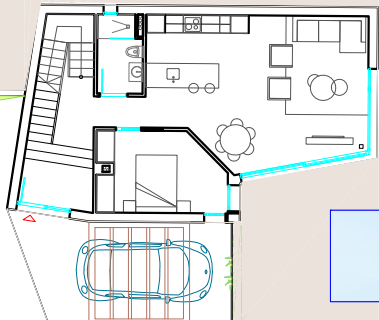

4

Plot: 186,30 m<sup>2</sup>

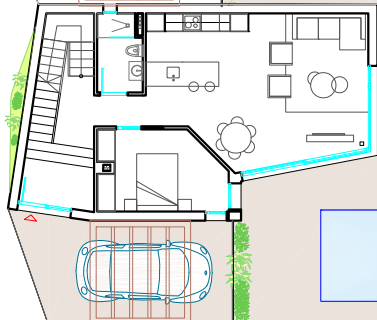

6

Plot: 182,90 m<sup>2</sup>

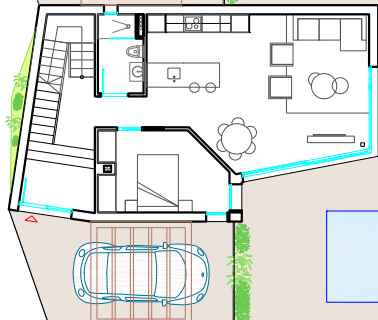

8

Plot: 178,80 m<sup>2</sup>

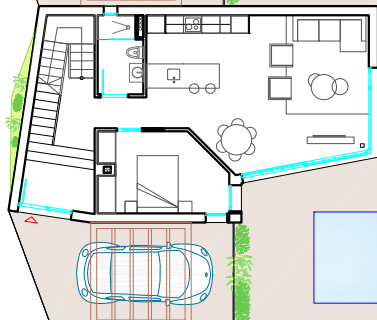

10

Plot: 197,80 m<sup>2</sup>

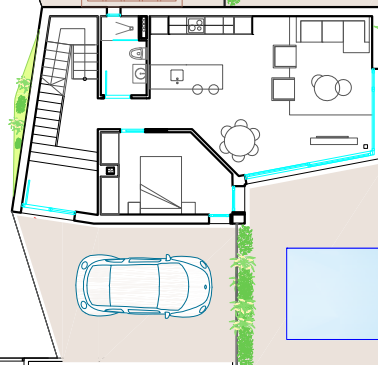

Z.C

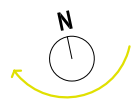

CALLE LEMAN

Plot: 305,21 m<sup>2</sup>

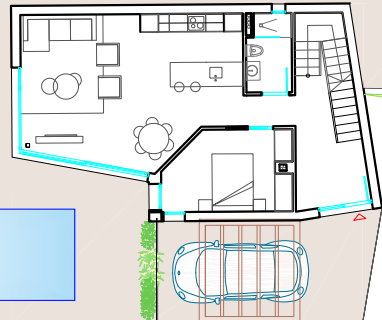

Plot: 185,10 m<sup>2</sup>

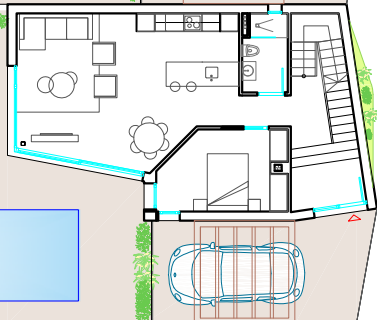

Plot: 181,50 m<sup>2</sup>

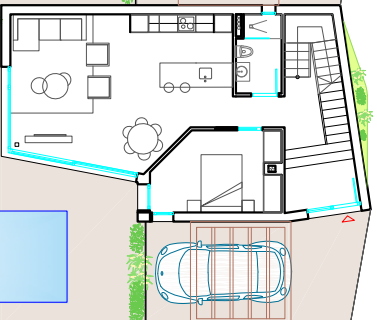

Plot: 178,30 m<sup>2</sup>

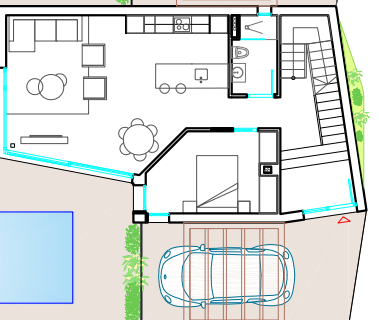

Plot: 197,50 m<sup>2</sup>

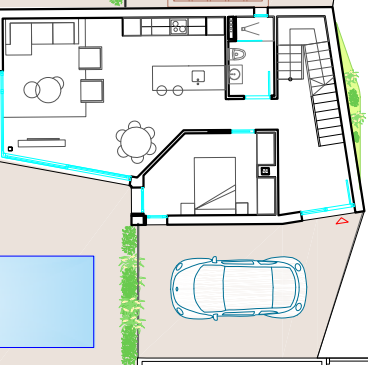

1

3

5

7

9

Marzo 2023

# VIVIENDA 1

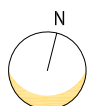
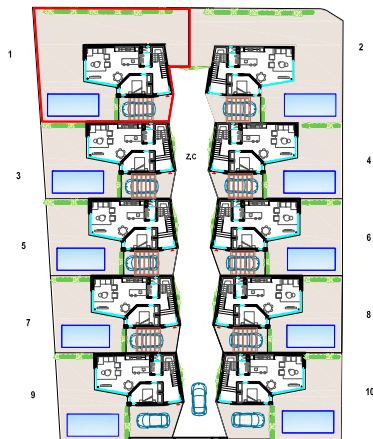
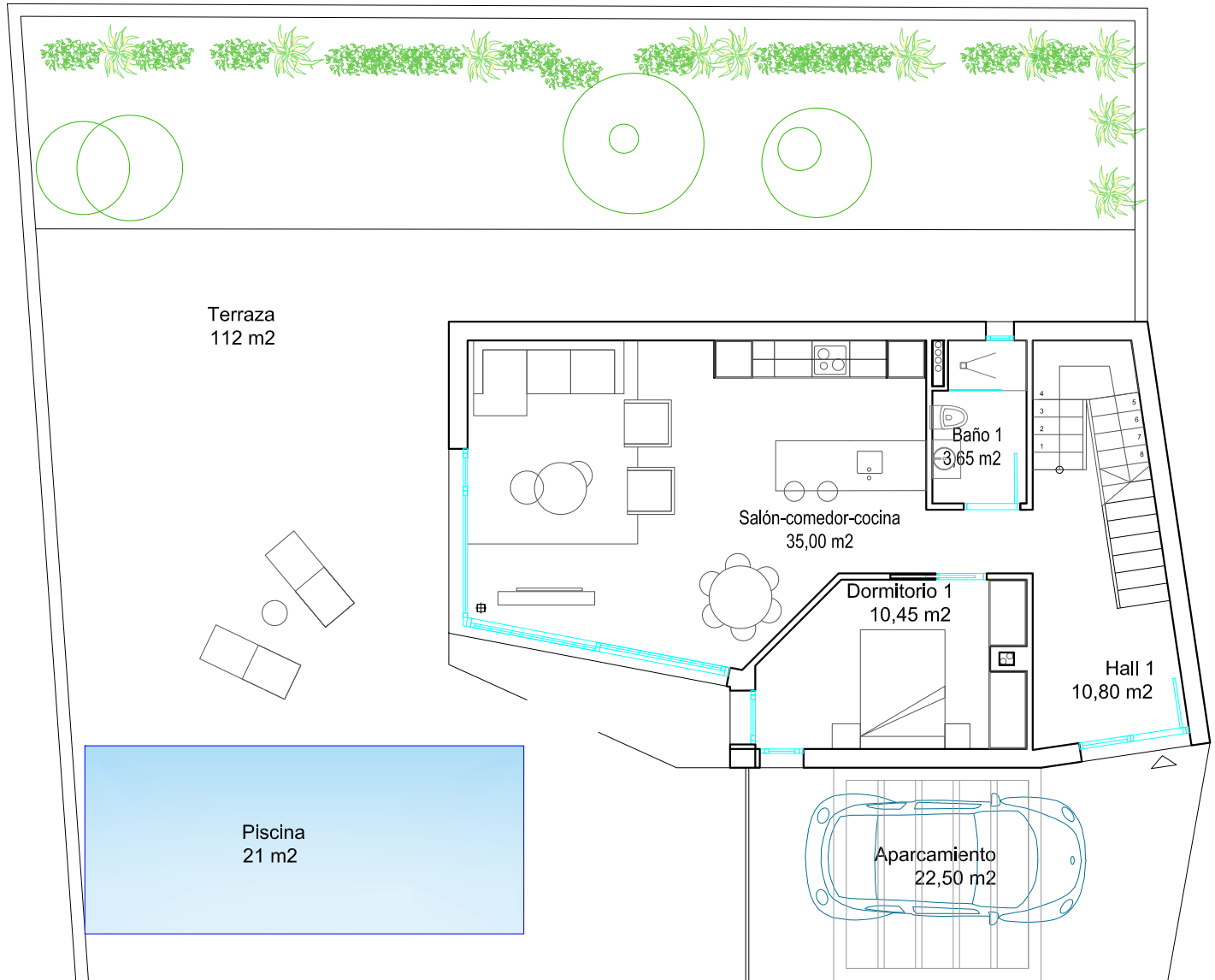

## PLANTA BAJA

SUPERFICIE ÚTIL (SU)	62,10 M2
SUPERFICIE CONSTRUIDA (SC)	76,30 M2
TERRAZA	112,25 M2
APARCAMIENTO	22,50 M2
PISCINA	21,00 M2

(SC + TERRAZA + APARCAMIENTO+PISCINA)

**TOTAL VIVIENDA PB**  
**232,00 M2**

# VIVIENDA 1

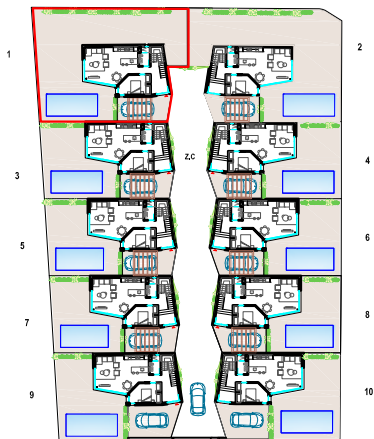
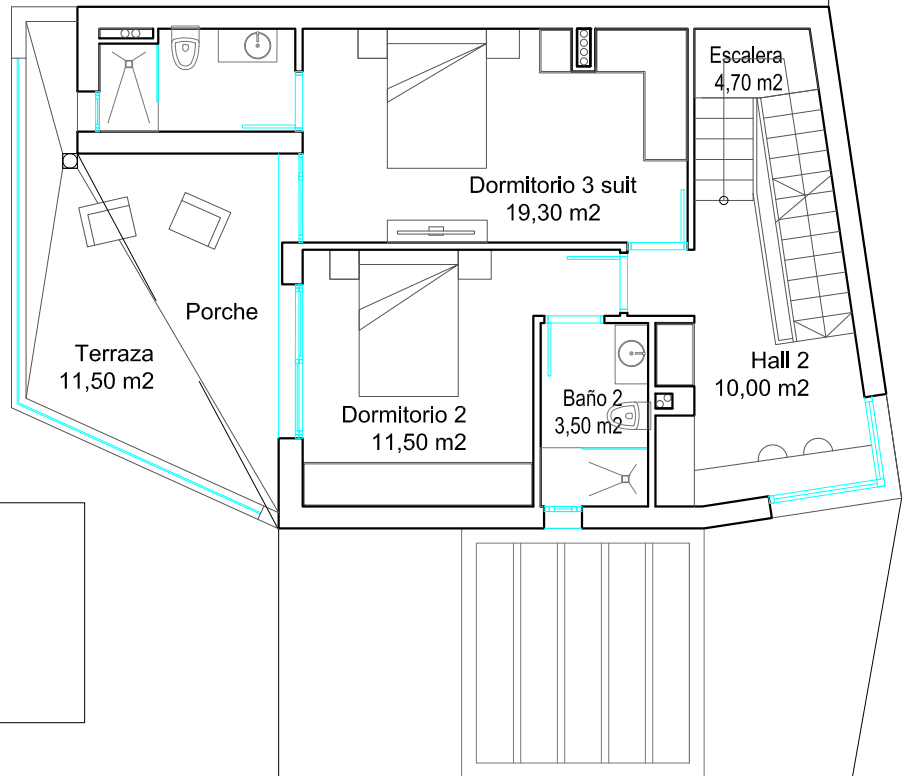

## PLANTA 1

SUPERFICIE ÚTIL (SU)	52,50 M2
SUPERFICIE CONSTRUIDA (SC)	65,00 M2
TERRAZA	11,50 M2

## TOTAL VIVIENDA P1

(SC + TERRAZA)

76,50 M2



# VIVIENDA 1

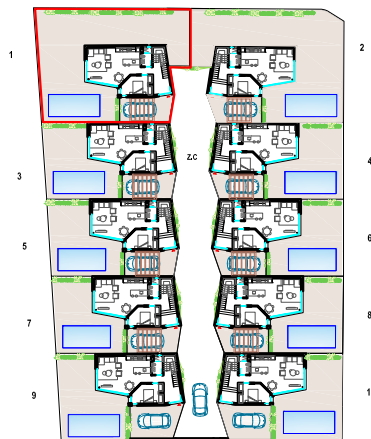
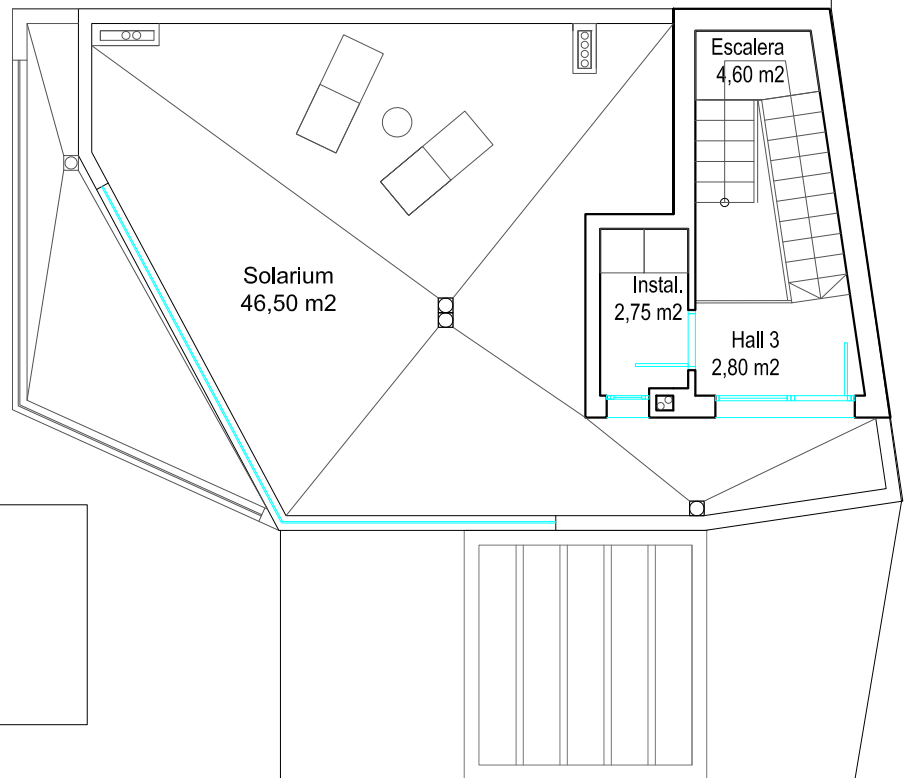

## PLANTA 2-SOLARIUM

SUPERFICIE ÚTIL (SU)	10,15 M2
SUPERFICIE CONSTRUIDA (SC)	17,25 M2
SOLARIUM	46,50 M2
<b>TOTAL VIVIENDA P2-SOLARIUM (SC + SOLARIUM)</b>	<b>63,75 M2</b>

<b>SUPERFICIES TOTALES</b>	
SUPERFICIE CONSTRUIDA TOTAL (SCT)	158,55 M2
SUPERFICIE ÚTIL TOTAL (SUT)	124,75 M2
APARCAMIENTO	22,50 M2
TERRAZAS	106,50 M2
SOLARIUM	46,50 M2
PISCINA	21,00 M2
<b>SUPERFICIE TOTAL VIVIENDA</b>	<b>355,05 M2</b>

**PARCELA (305,21 M2), OCUPACIÓN EN PLANTA (77,30 M2)**

## VIVIENDA 2

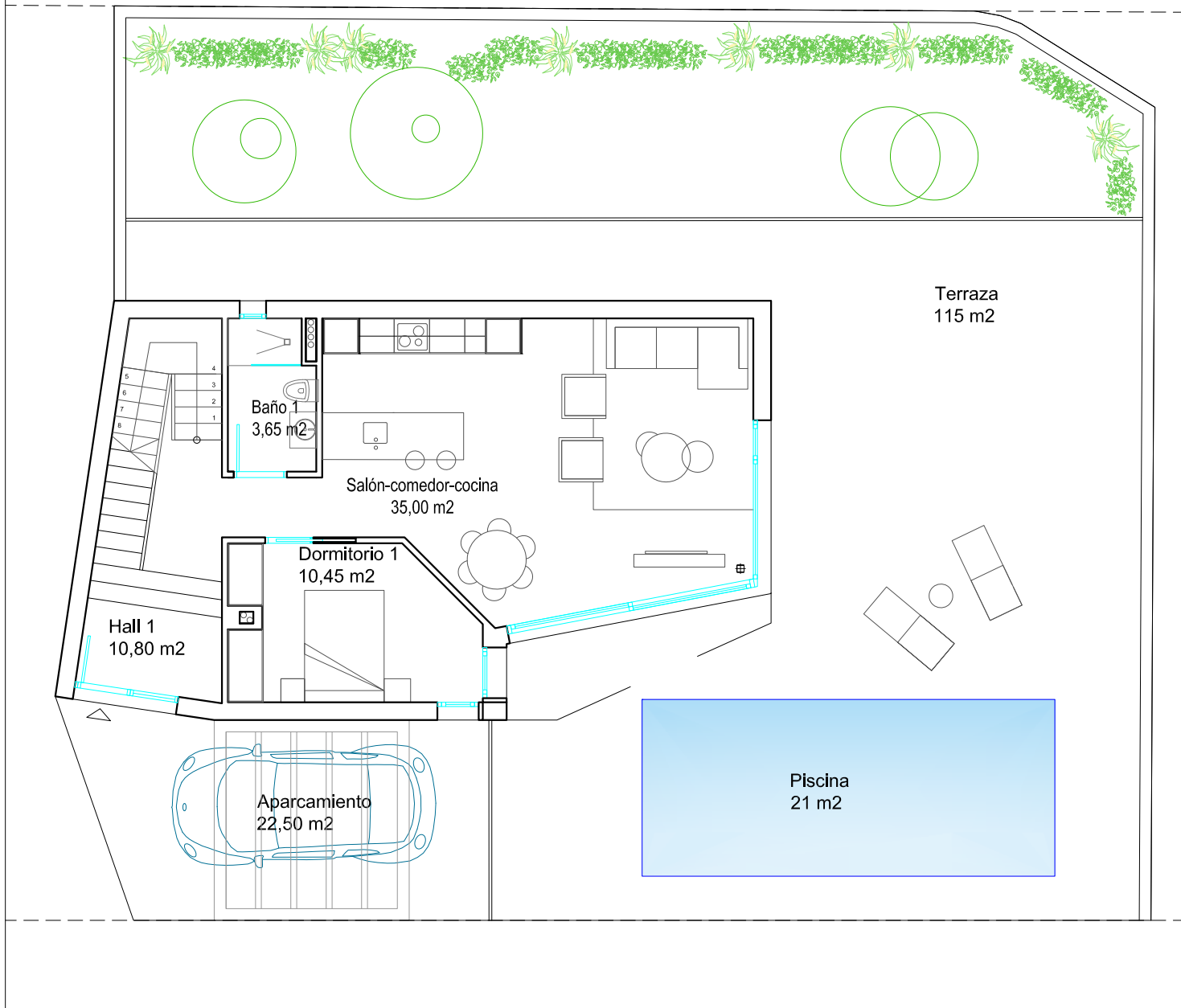

### PLANTA BAJA

SUPERFICIE ÚTIL (SU)	62,10 M <sup>2</sup>
SUPERFICIE CONSTRUIDA (SC)	76,30 M <sup>2</sup>
TERRAZA	115,30 M <sup>2</sup>
APARCAMIENTO	22,50 M <sup>2</sup>
PISCINA	21,00 M <sup>2</sup>

**TOTAL VIVIENDA PB**  
**(SC + TERRAZA + APARCAMIENTO+PISCINA)**

**235,10 M<sup>2</sup>**

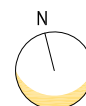
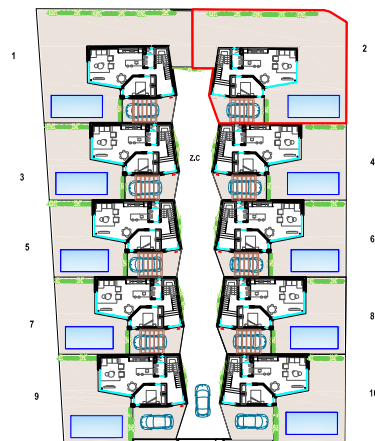

## VIVIENDA 2

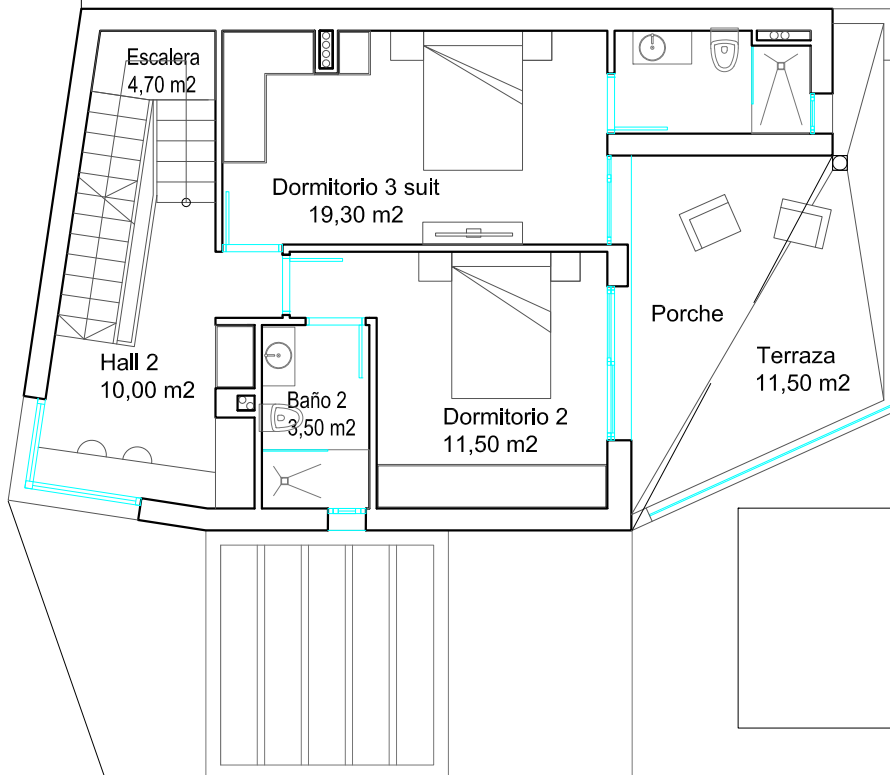

### PLANTA 1

SUPERFICIE ÚTIL (SU)	52,50 M2
SUPERFICIE CONSTRUIDA (SC)	65,00 M2
TERRAZA	11,50 M2
<b>TOTAL VIVIENDA P1 (SC + TERRAZA)</b>	<b>76,50 M2</b>

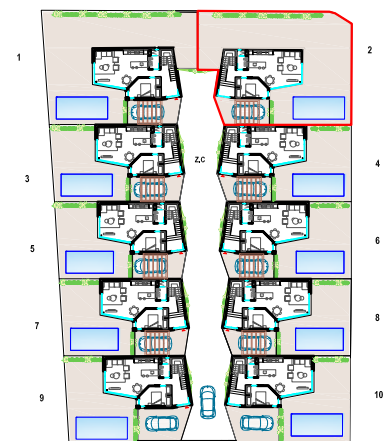

## VIVIENDA 2

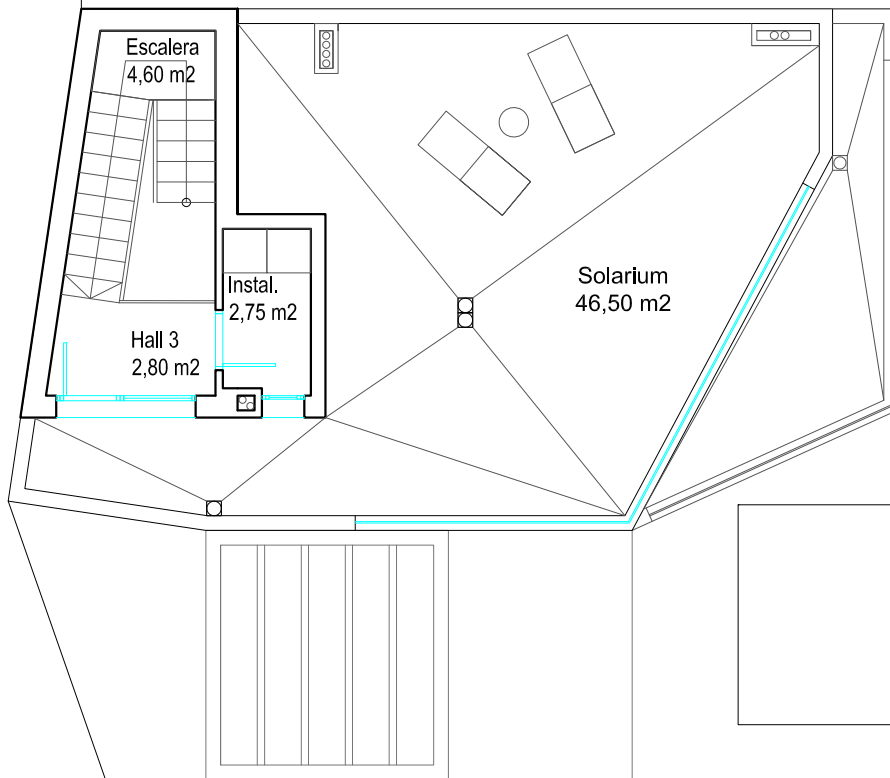

### PLANTA 2-SOLARIUM

SUPERFICIE ÚTIL (SU)	10,15 M2
SUPERFICIE CONSTRUIDA (SC)	17,25 M2
SOLARIUM	46,50 M2
<b>TOTAL VIVIENDA P2-SOLARIUM (SC + SOLARIUM)</b>	<b>63,75 M2</b>

### SUPERFICIES TOTALES

SUPERFICIE CONSTRUIDA TOTAL (SCT)	158,55 M2
SUPERFICIE ÚTIL TOTAL (SUT)	124,75 M2
APARCAMIENTO	22,50 M2
TERRAZAS	101,50 M2
SOLARIUM	46,50 M2
PISCINA	21,00 M2
<b>SUPERFICIE TOTAL VIVIENDA</b>	<b>350,05 M2</b>

**PARCELA (300,27 M2), OCUPACIÓN EN PLANTA (77,30 M2)**

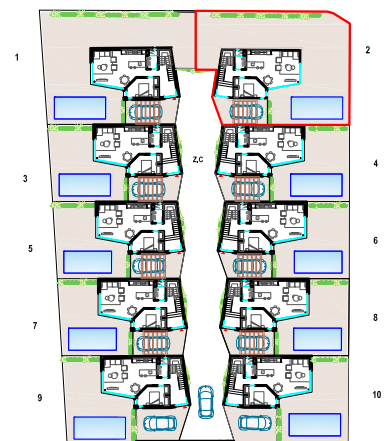

# VIVIENDA 3

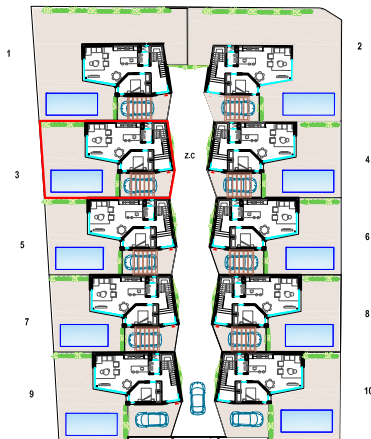
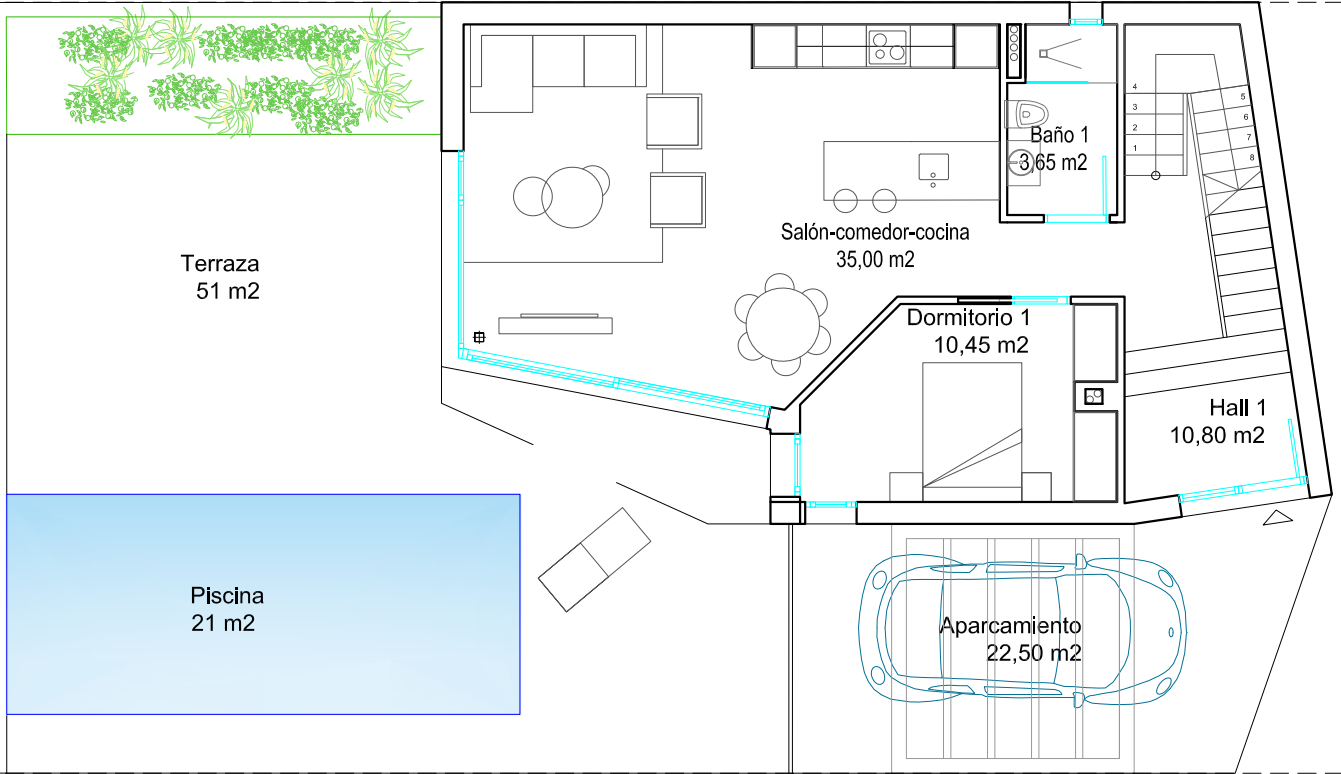

## PLANTA BAJA

SUPERFICIE ÚTIL (SU)	62,10 M <sup>2</sup>
SUPERFICIE CONSTRUIDA (SC)	76,30 M <sup>2</sup>
TERRAZA	51,00 M <sup>2</sup>
APARCAMIENTO	22,50 M <sup>2</sup>
PISCINA	21,00 M <sup>2</sup>

**TOTAL VIVIENDA PB**  
**170,80 M<sup>2</sup>**

**(SC + TERRAZA + APARCAMIENTO+PISCINA)**

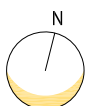



# VIVIENDA 3

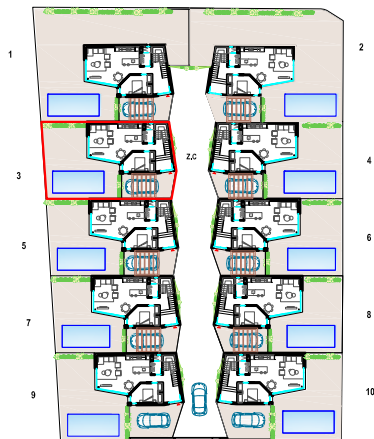
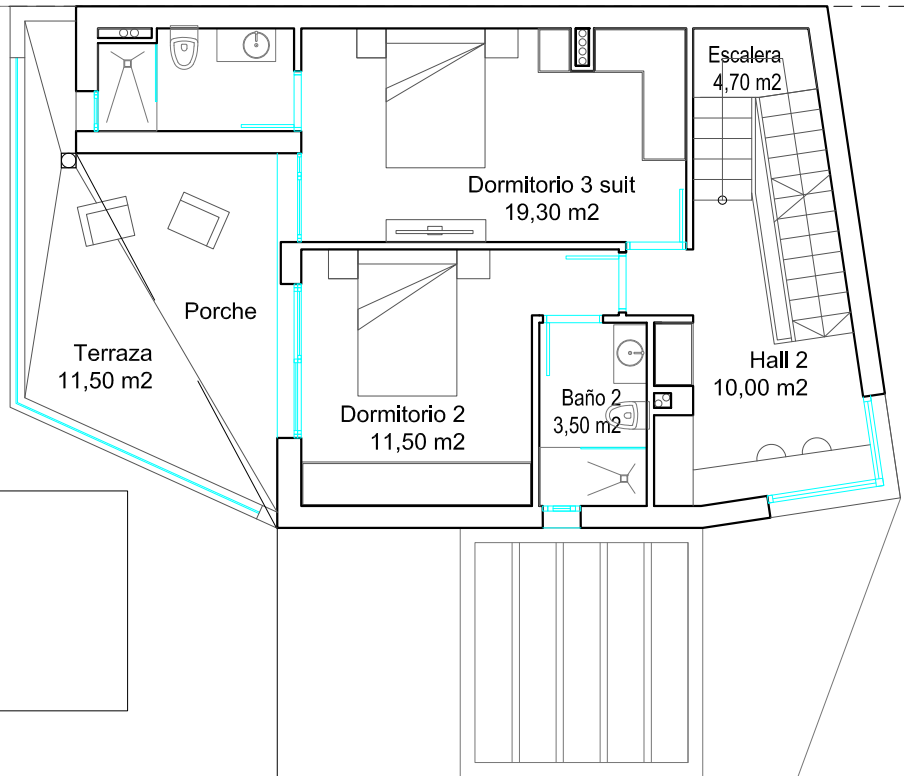

## PLANTA 1

SUPERFICIE ÚTIL (SU)	52,50 M <sup>2</sup>
SUPERFICIE CONSTRUIDA (SC)	65,00 M <sup>2</sup>
TERRAZA	11,50 M <sup>2</sup>

**(SC + TERRAZA)**

**TOTAL VIVIENDA P1**  
76,50 M<sup>2</sup>



## VIVIENDA 3

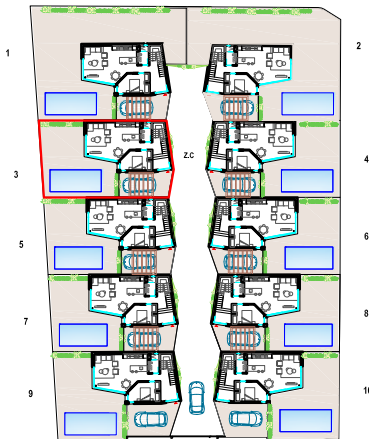
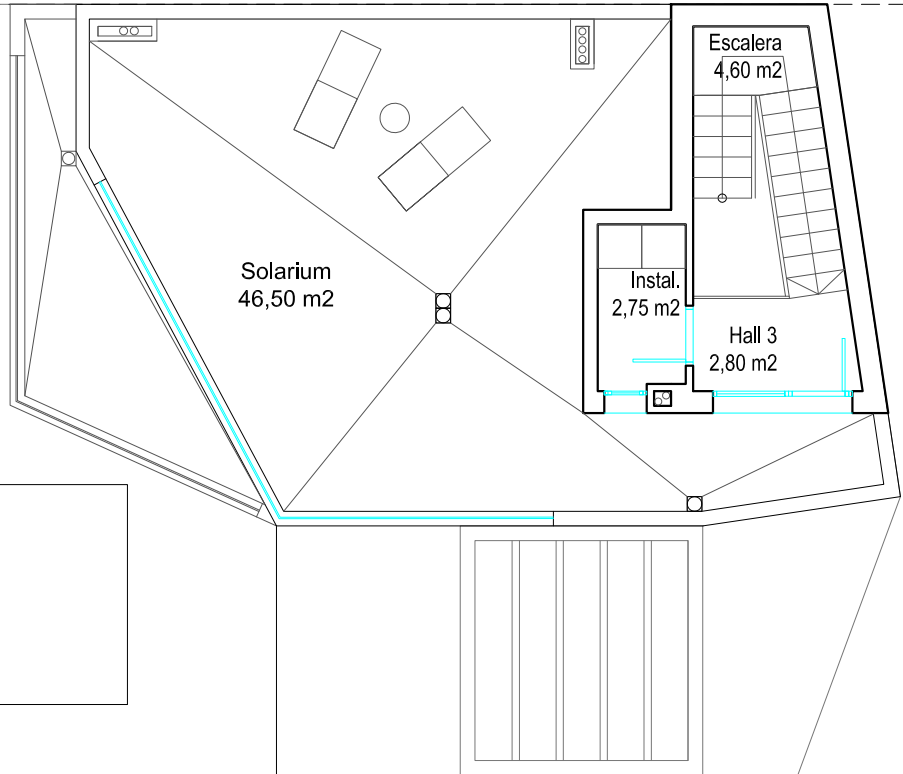

### PLANTA 2-SOLARIUM

SUPERFICIE ÚTIL (SU)	10,15 M2
SUPERFICIE CONSTRUIDA (SC)	17,25 M2
SOLARIUM	46,50 M2
<b>TOTAL VIVIENDA P2-SOLARIUM (SC + SOLARIUM)</b>	<b>63,75 M2</b>

<b>SUPERFICIES TOTALES</b>	
SUPERFICIE CONSTRUIDA TOTAL (SCT)	158,55 M2
SUPERFICIE ÚTIL TOTAL (SUT)	124,75 M2
APARCAMIENTO	22,50 M2
TERRAZAS	65,50 M2
SOLARIUM	46,50 M2
PISCINA	21,00 M2
<b>SUPERFICIE TOTAL VIVIENDA</b>	<b>314,05 M2</b>

**PARCELA (185,10 M2), OCUPACIÓN EN PLANTA ( 77,30 M2)**

# VIVIENDA 4

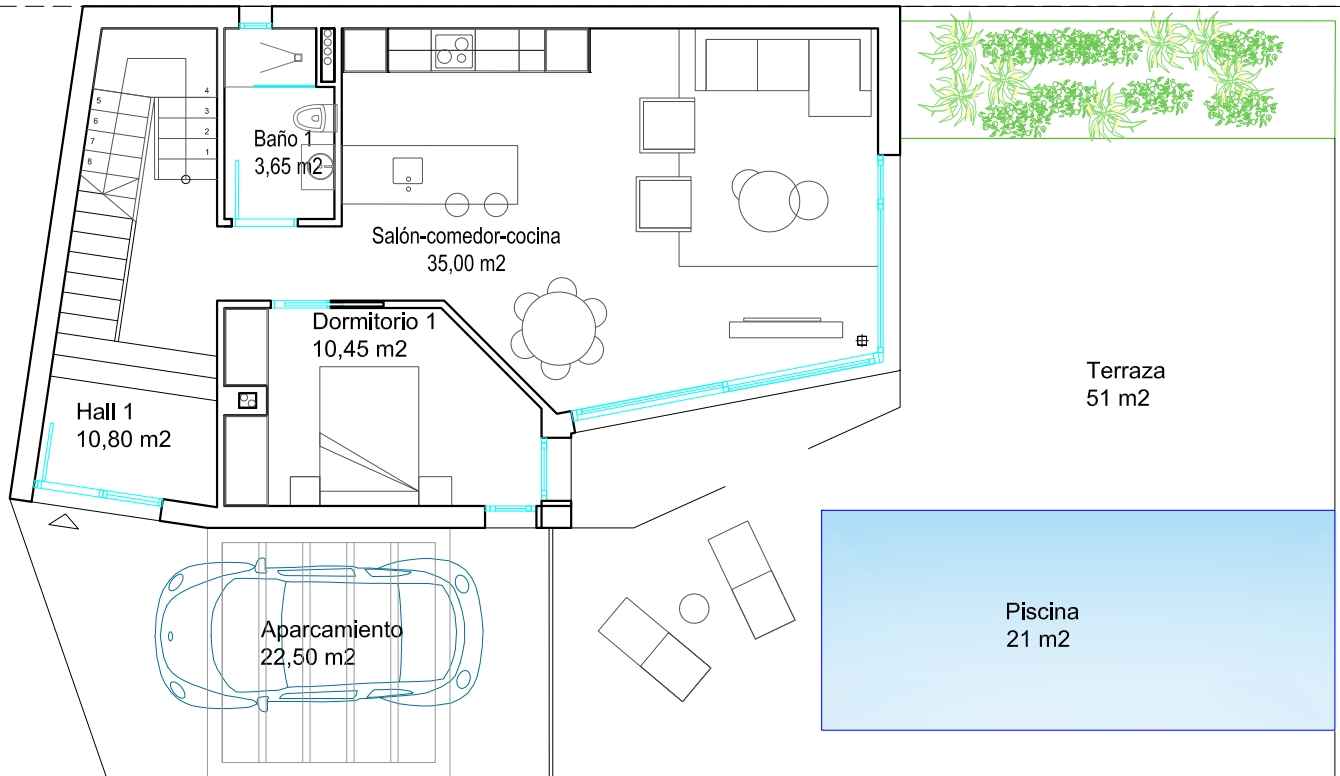

## PLANTA BAJA

SUPERFICIE ÚTIL (SU)	62,10 M2
SUPERFICIE CONSTRUIDA (SC)	76,30 M2
TERRAZA	51,00 M2
APARCAMIENTO	22,50 M2
PISCINA	21,00 M2

**TOTAL VIVIENDA PB  
(SC + TERRAZA + APARCAMIENTO+PISCINA) 170,80 M2**

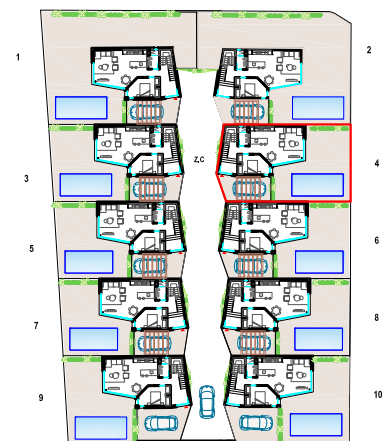

# VIVIENDA 4

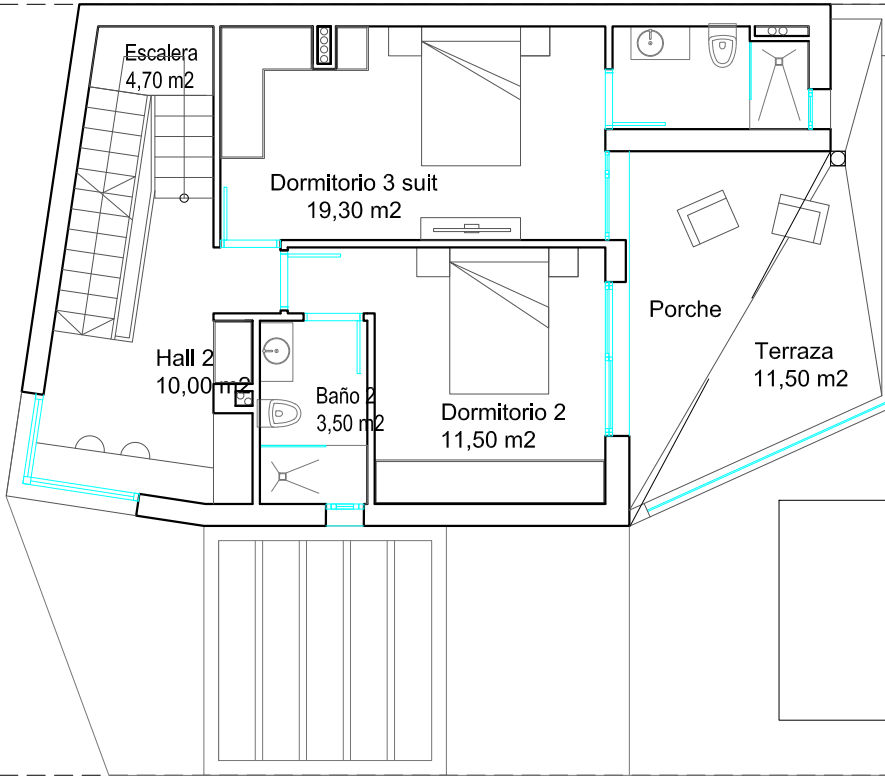

## PLANTA 1

SUPERFICIE ÚTIL (SU)	52,50 M2
SUPERFICIE CONSTRUIDA (SC)	65,00 M2
TERRAZA	11,50 M2
<b>TOTAL VIVIENDA P1 (SC + TERRAZA)</b>	<b>76,50 M2</b>

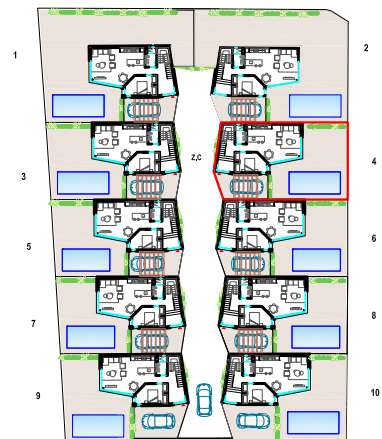

## VIVIENDA 4

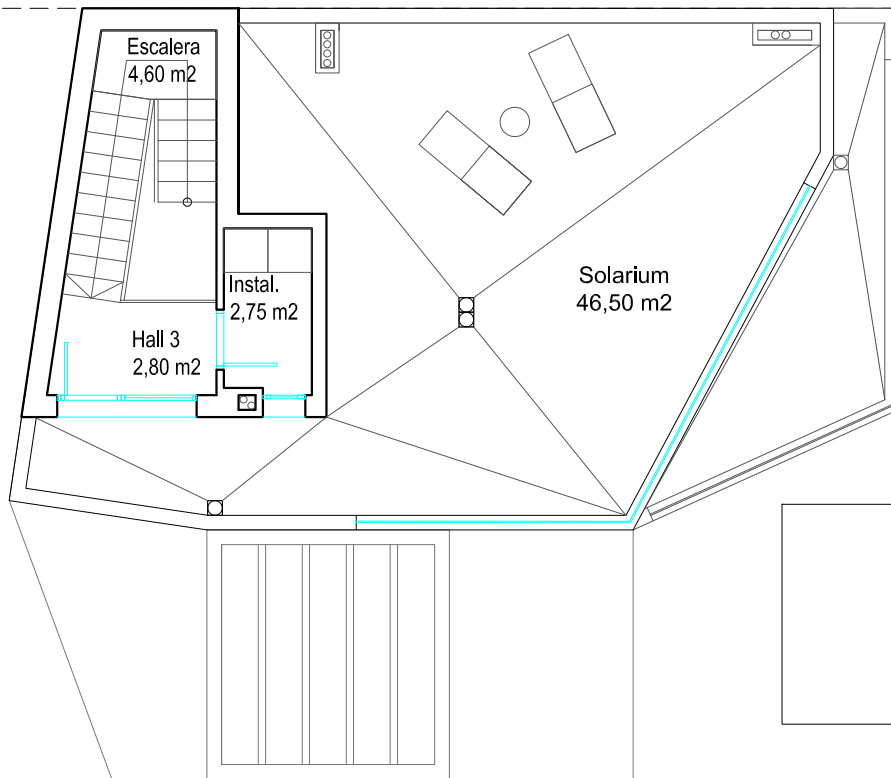

### PLANTA 2-SOLARIUM

SUPERFICIE ÚTIL (SU)	10,15 M2
SUPERFICIE CONSTRUIDA (SC)	17,25 M2
SOLARIUM	46,50 M2
<b>TOTAL VIVIENDA P2-SOLARIUM (SC + SOLARIUM)</b>	<b>63,75 M2</b>

### SUPERFICIES TOTALES

SUPERFICIE CONSTRUIDA TOTAL (SCT)	158,55 M2
SUPERFICIE ÚTIL TOTAL (SUT)	124,75 M2
APARCAMIENTO	22,50 M2
TERRAZAS	65,50 M2
SOLARIUM	46,50 M2
PISCINA	21,00 M2
<b>SUPERFICIE TOTAL VIVIENDA</b>	<b>314,05 M2</b>

**PARCELA (186,30 M2), OCUPACIÓN EN PLANTA ( 77,30 M2)**

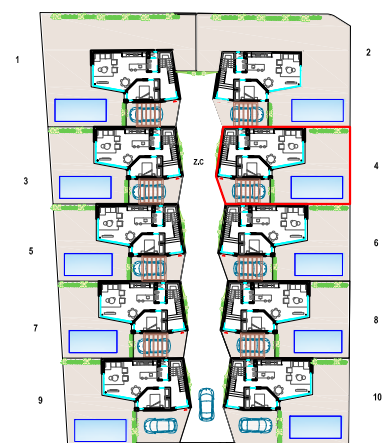

# VIVIENDA 7

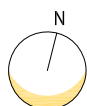
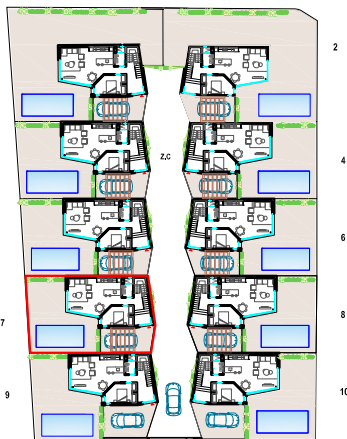
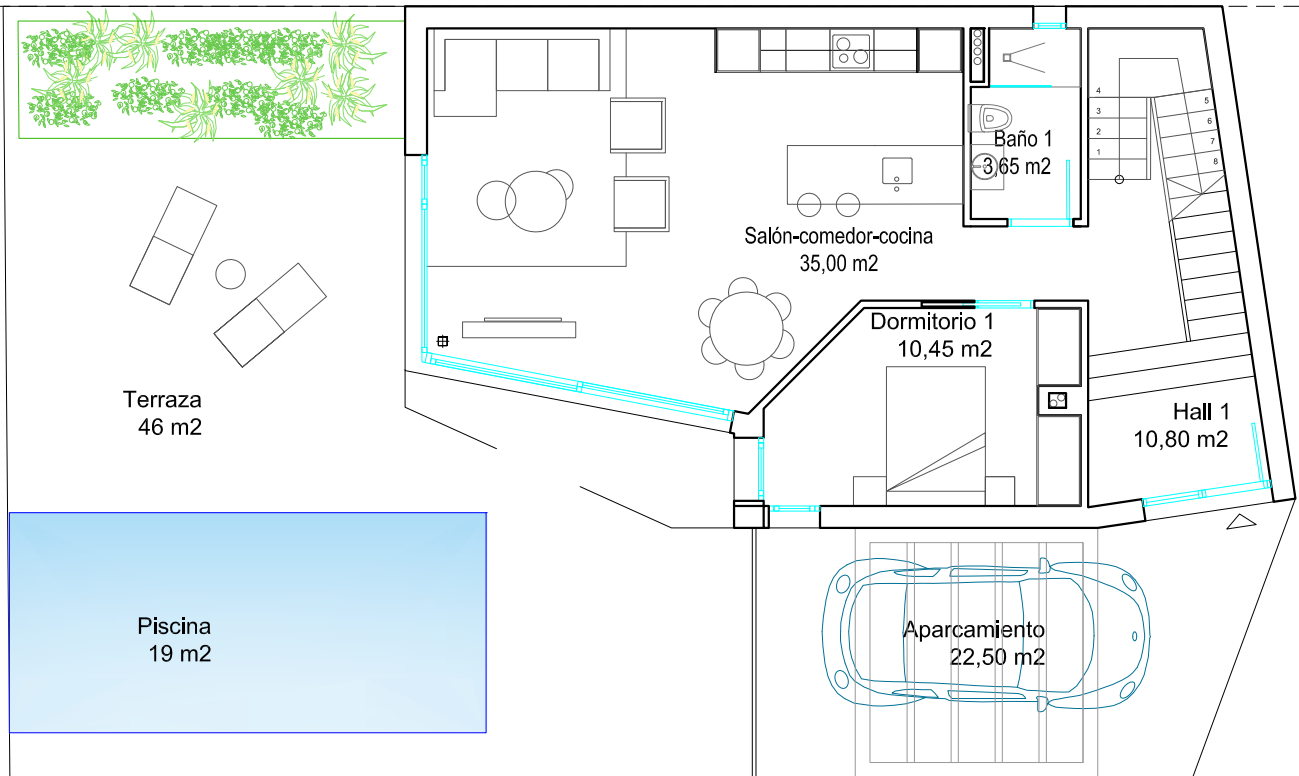

## PLANTA BAJA

SUPERFICIE ÚTIL (SU)	62,10 M2
SUPERFICIE CONSTRUIDA (SC)	76,30 M2
TERRAZA	46,00 M2
APARCAMIENTO	22,50 M2
PISCINA	19,00 M2

(SC + TERRAZA + APARCAMIENTO+PISCINA)

**TOTAL VIVIENDA PB**  
163,80 M2

# VIVIENDA 7

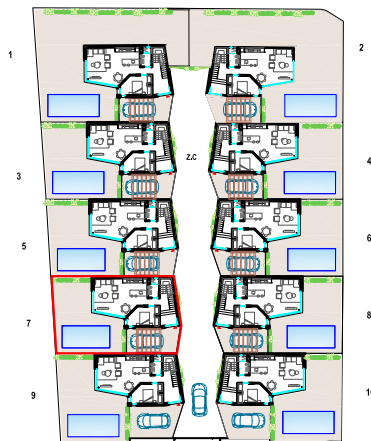
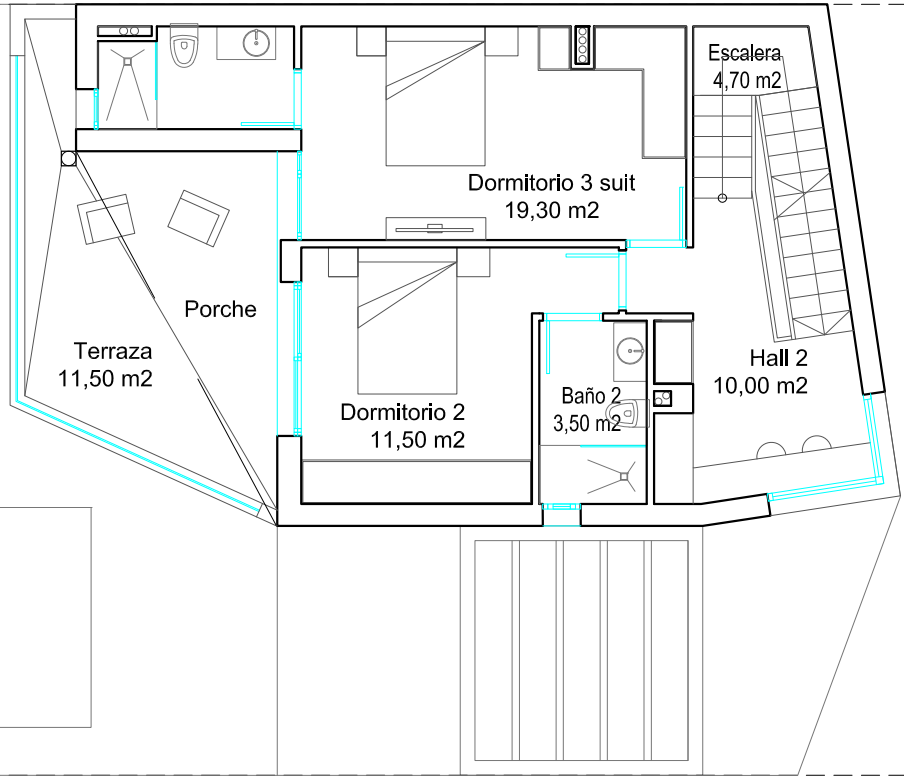

## PLANTA 1

SUPERFICIE ÚTIL (SU)	52,50 M <sup>2</sup>
SUPERFICIE CONSTRUIDA (SC)	65,00 M <sup>2</sup>
TERRAZA	11,50 M <sup>2</sup>

## TOTAL VIVIENDA P1

**(SC + TERRAZA)**

**76,50 M<sup>2</sup>**



## VIVIENDA 7

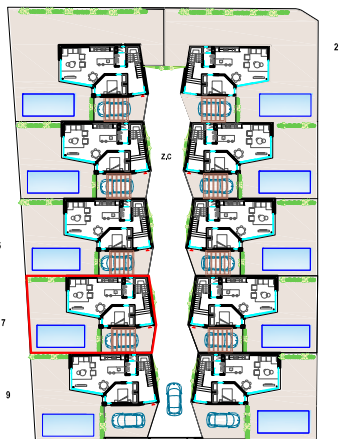
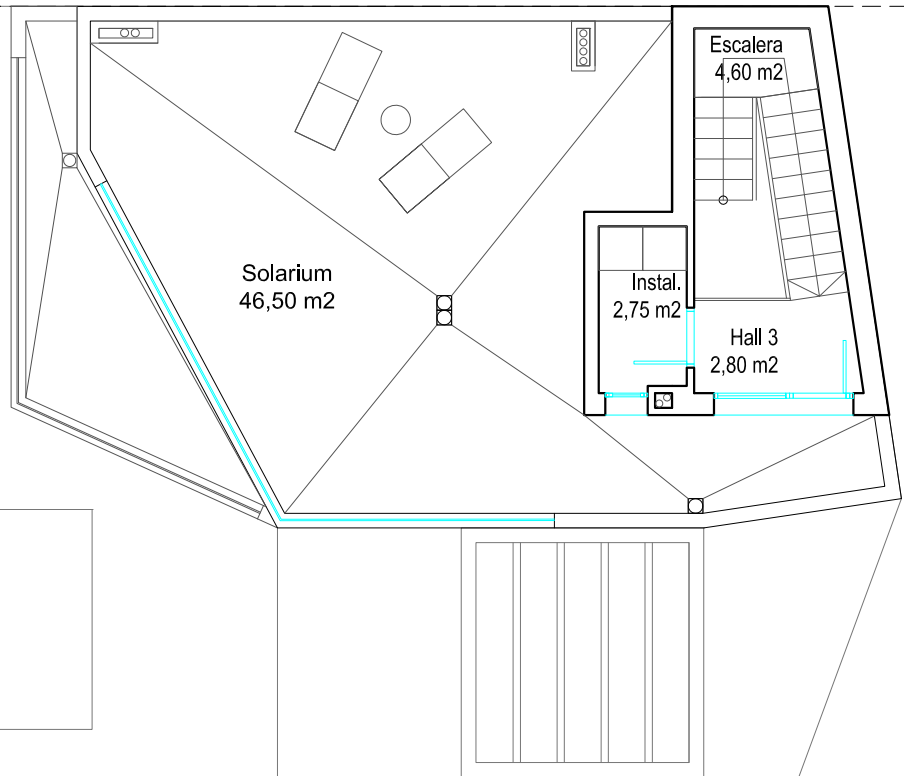

### PLANTA 2-SOLARIUM

SUPERFICIE ÚTIL (SU)	10,15 M2
SUPERFICIE CONSTRUIDA (SC)	17,25 M2
SOLARIUM	46,50 M2
<b>TOTAL VIVIENDA P2-SOLARIUM (SC + SOLARIUM)</b>	<b>63,75 M2</b>

<b>SUPERFICIES TOTALES</b>	
SUPERFICIE CONSTRUIDA TOTAL (SCT)	158,55 M2
SUPERFICIE ÚTIL TOTAL (SUT)	124,75 M2
APARCAMIENTO	22,50 M2
TERRAZAS	57,50 M2
SOLARIUM	46,50 M2
PISCINA	19,00 M2
<b>SUPERFICIE TOTAL VIVIENDA</b>	<b>304,05 M2</b>

**PARCELA (178,30 M2), OCUPACIÓN EN PLANTA ( 77,30 M2)**